

Varenummer: 204060M1675A1U

Beskrivelse: E+G Justerfod
GN 40-60-M16-75-A1-U

Note: U Uden møtrik, sekskant i toppen, spændeflade i bunden

Mål

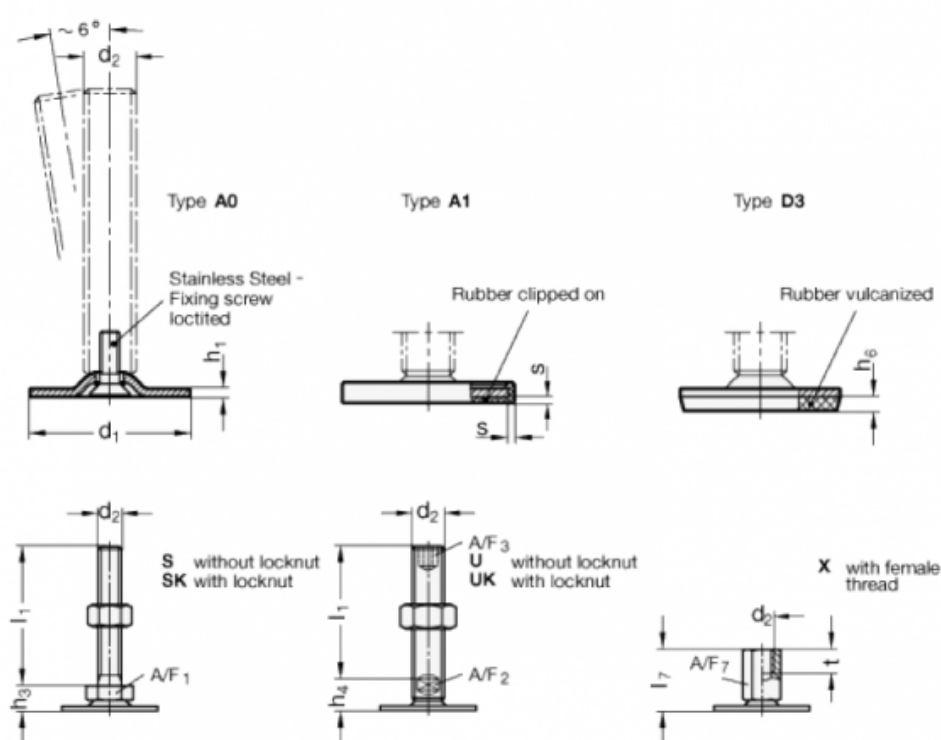

A/F2 = 12

s = 2

A/F3 = 8

d1 = 60

d2 = M16

h1 = 2.5

h4 = 17

h6 =

l1 = 75